



**Security level: Class S2 according to EN 14450**  
**Security level: B according to VDMA 24992 -**  
**Conditions May '95**

Suitable for the storage of:  
 keys

**Description**  
 Kiel series - wall safes (to built-in).  
 Adjustable (every 14 mm), colourful and numbered  
 hook bars. Index holder in standard.

**Body:** single-walled body (2 mm thick)  
**Door:** double-walled door (52 mm thick)  
**Locking:** 4-way locking system - incl. overlapping profile on the hinge side

**Standard option**  
**Lock:** high security key lock I class VdS with two keys (65 mm)  
**Hinges:** internal  
**Door opening angle:** 90°  
**Colour:** RAL 7035 (light grey)

Art. No.	Model	Outer dimensions*			Inner dimensions			Door light		Anchoring		Hooks in total	Weight
		Height mm	Width mm	Depth mm	Height mm	Width mm	Depth mm	Height mm	Width mm	Bottom number	Backwall number	Number	Kg
11000	Kiel	420	420	200	354	354	122	354	274	0	0	70	22
11001	Kiel	600	420	200	534	354	122	534	274	0	0	100	30
11002	Kiel	800	420	200	734	354	122	734	274	0	0	160	40

\* excluding hinges, handles and fittings



Body: single-walled body (2 mm thick)



Door: double-walled door (52 mm thick)

**Closure options**

Standard



Key lock

Options available against surcharge



Electronic lock



Electronic lock with mechanical emergency

**Accessories available against surcharge**



Key rings

**Colour options without surcharge**



 All information concerning weight, color and dimensions are noncommittal and subject to errors and changes. Minor deviations are conditional on the production process. Technical changes, modifications and printing errors reserved. Safes may be top-heavy, during commissioning, please exercise appropriate caution in accordance with the installation guide. Pictograms are not technical description of the product.

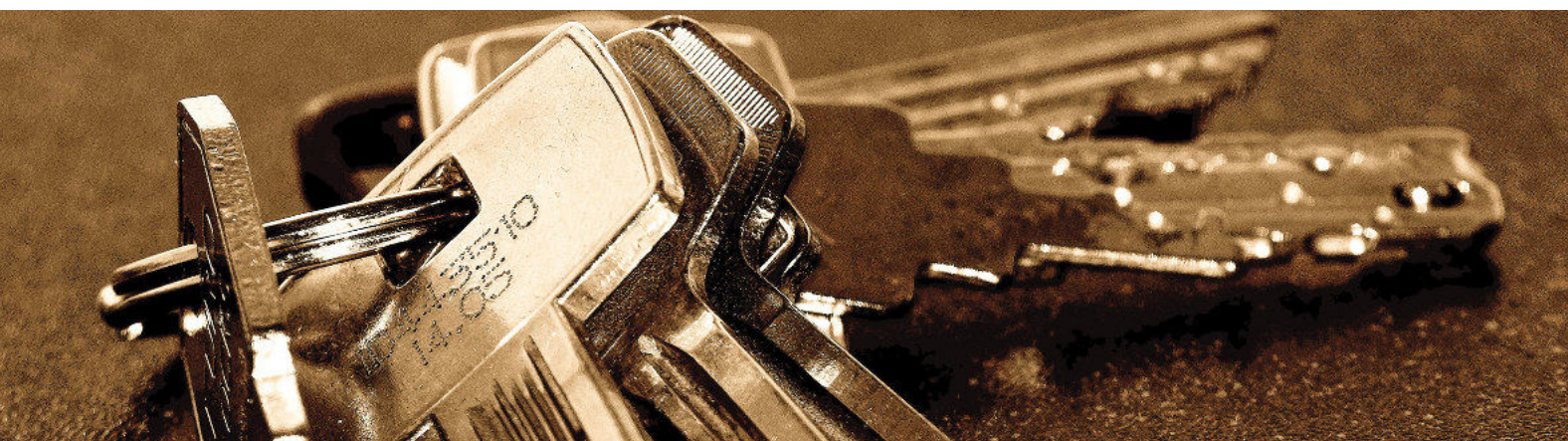

The picture shows an example of a key safe - model Mainz Art. no. 13006.



Key rings option against surcharge.



Color	Art. no.
blue	Art. 15023.00
green	Art. 15023.01
yellow	Art. 15023.02
red	Art. 15023.03
black	Art. 15023.04

Art. No.	Model	Hook bars			Hooks on hook bar			Partition wall Number	Hooks in total Number
		Back wall Number	Door Number	Partition wall Number	Back wall Number	Door Number	Partition wall Number		
11000	Kiel	3	4	-	10	10	-	70	
11001	Kiel	5	5	-	10	10	-	100	
11002	Kiel	8	8	-	10	10	-	160	

Hook bars

Standard

Art. no. 02010

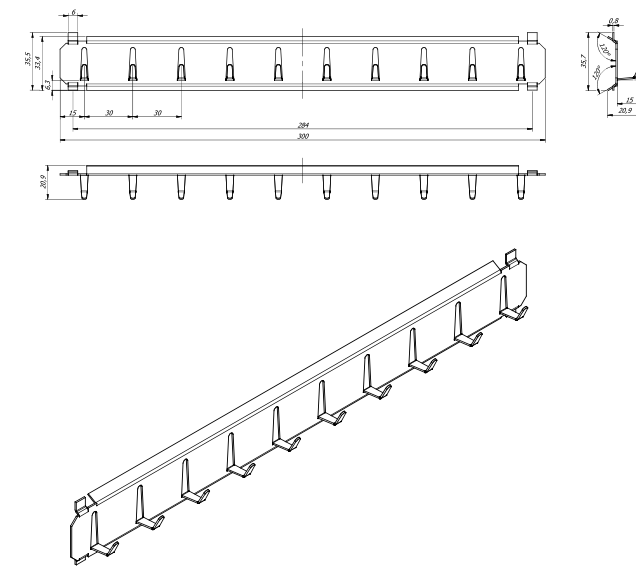

Hook bars options available against surcharge

Art. no. 02011

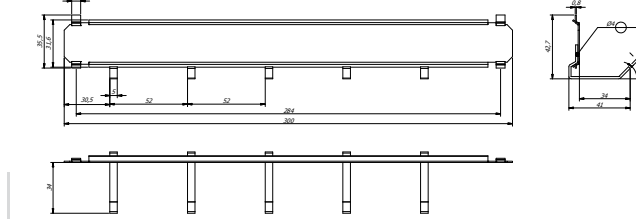

Art. no. 02012

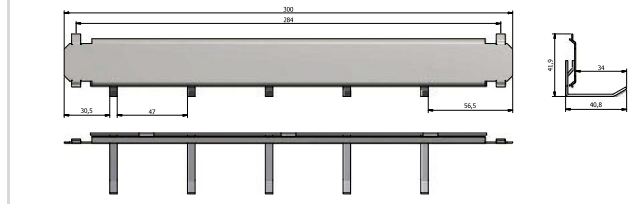

Art. no. 02013

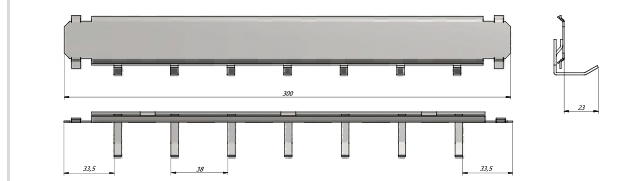

Art. no. 02014

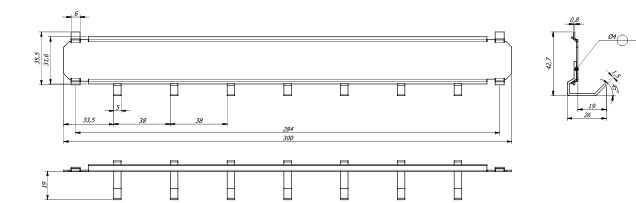

Bar

